

Serial number: 162735
 © Crown copyright and database right 2019
 Ordnance Survey licence 100048957
 Reproduction in whole or in part is prohibited
 without the prior permission of Ordnance Survey

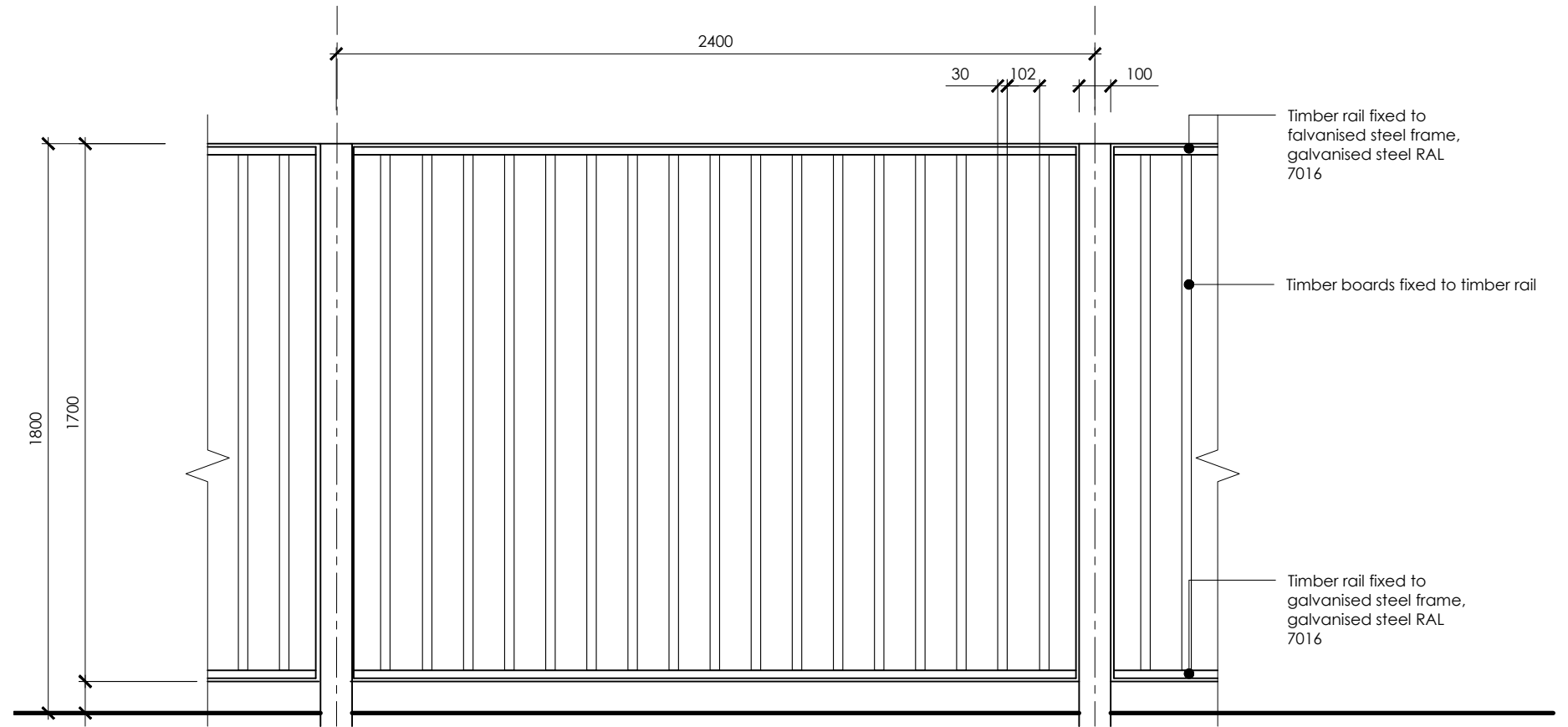

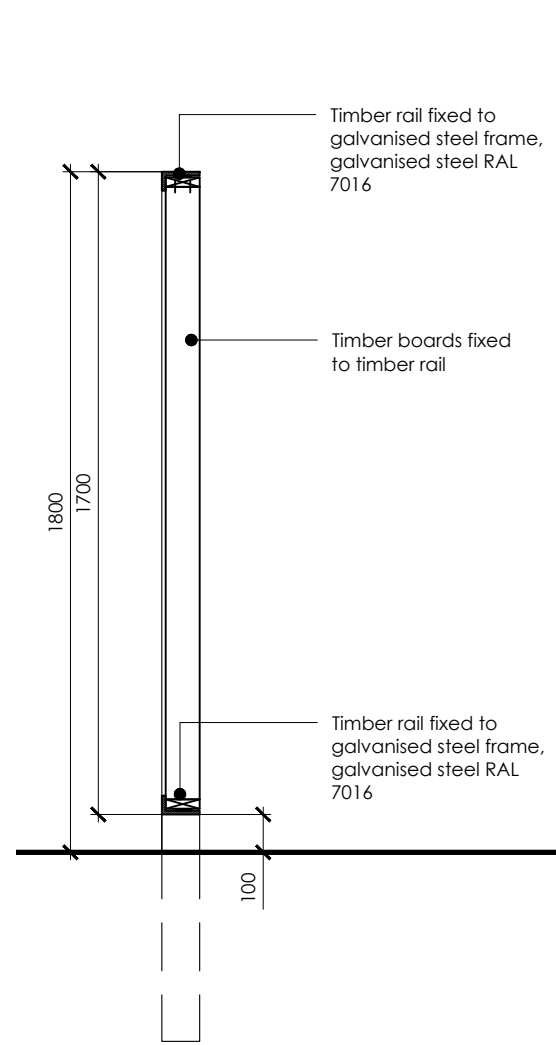

1 Fence section
@1:20

2 Fence elevation
@1:20

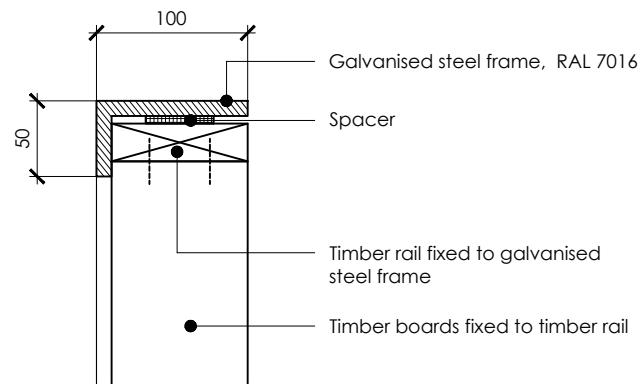

3 Fence section detail
@1:5

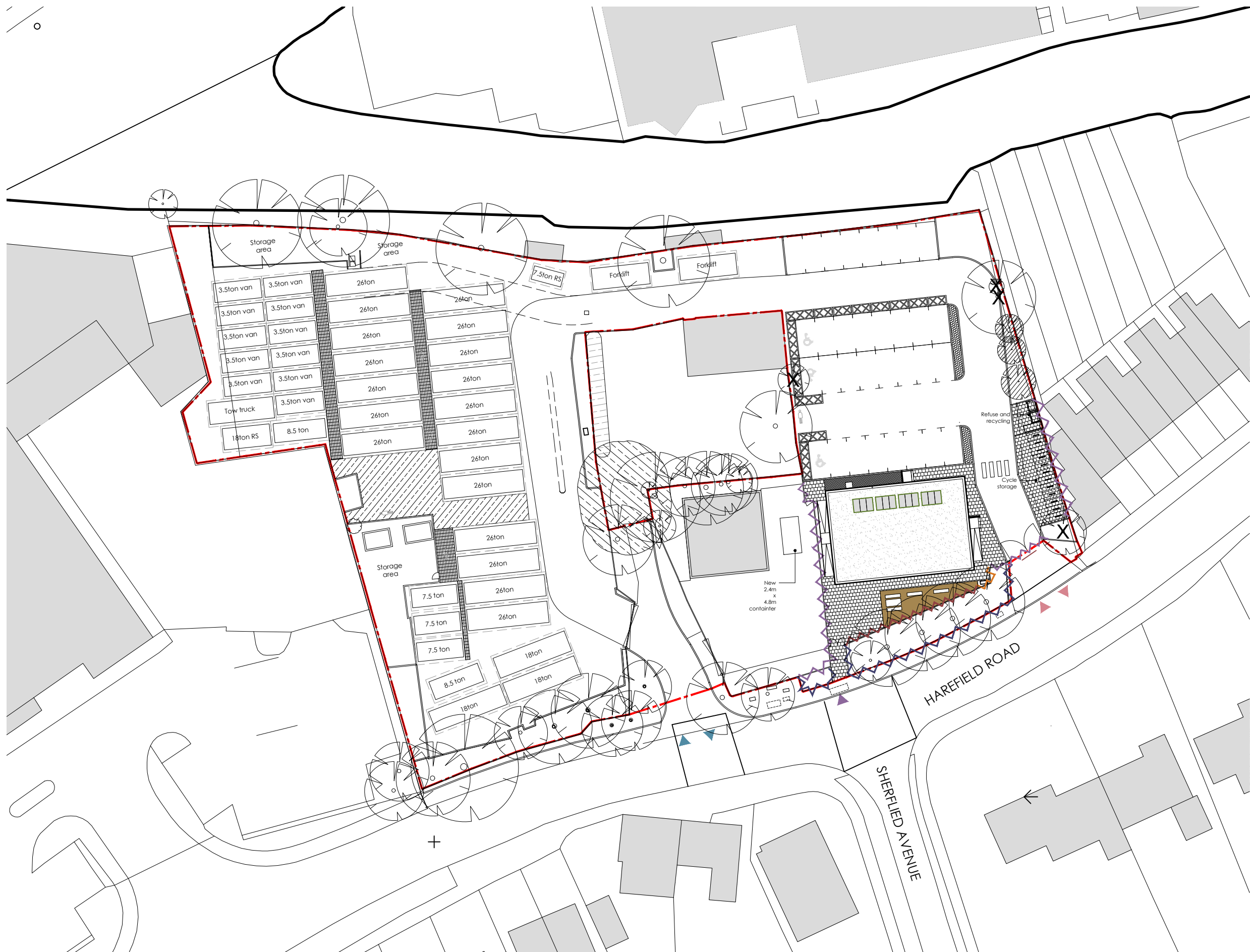

- Site boundary
- Operational vehicle access/egress
- Personal vehicle access/egress
- Pedestrian access
- Existing tree
- Existing tree - Group
- Proposed tree
- Existing tree to be removed
- Zone for condensors
- New amenity space
- 1800mm fence slotted fence
- 1800mm fence closed panel fence to match slotted fence and hide feeder pillar
- 600mm fence
- New closed board fence, height to match existing

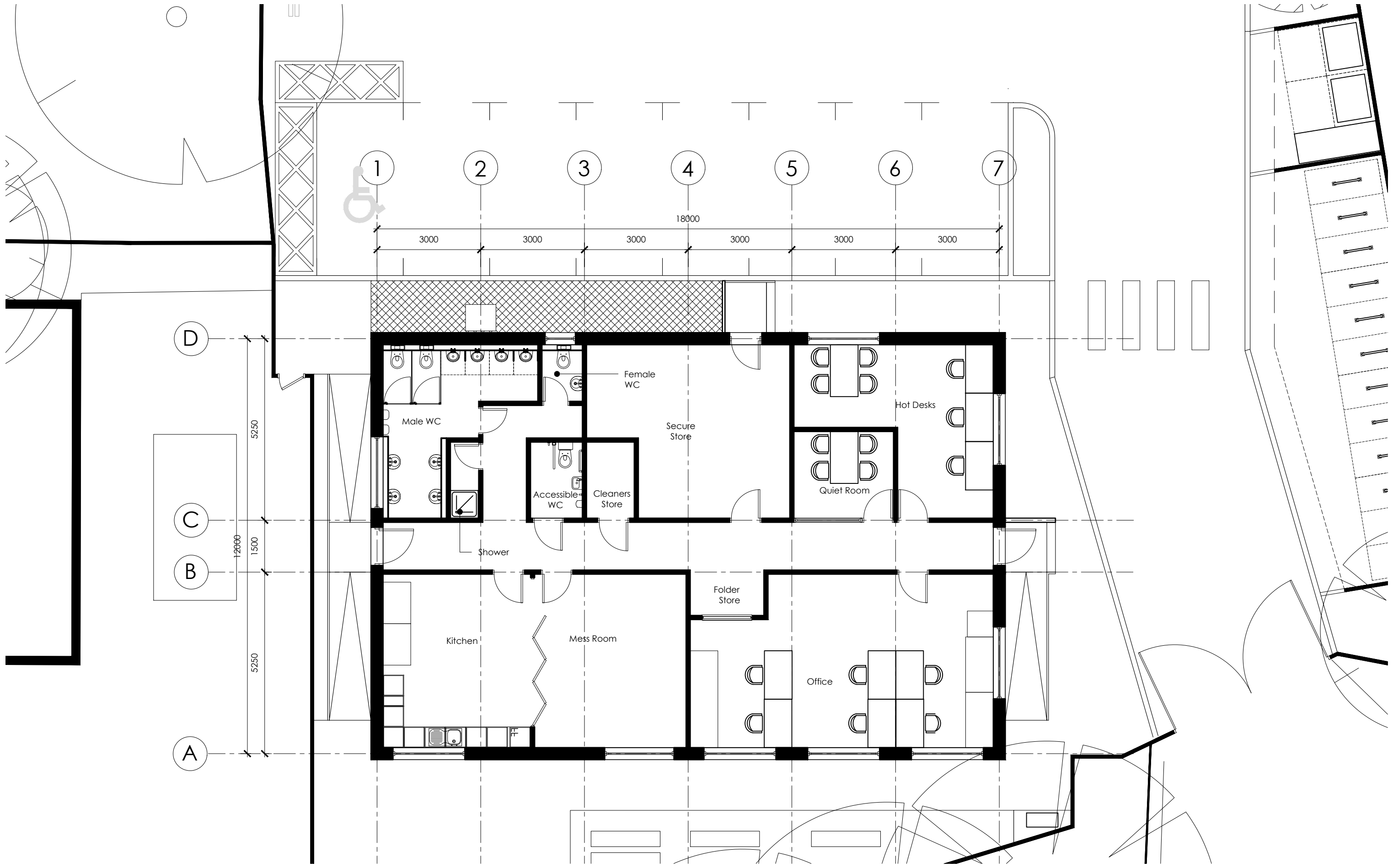

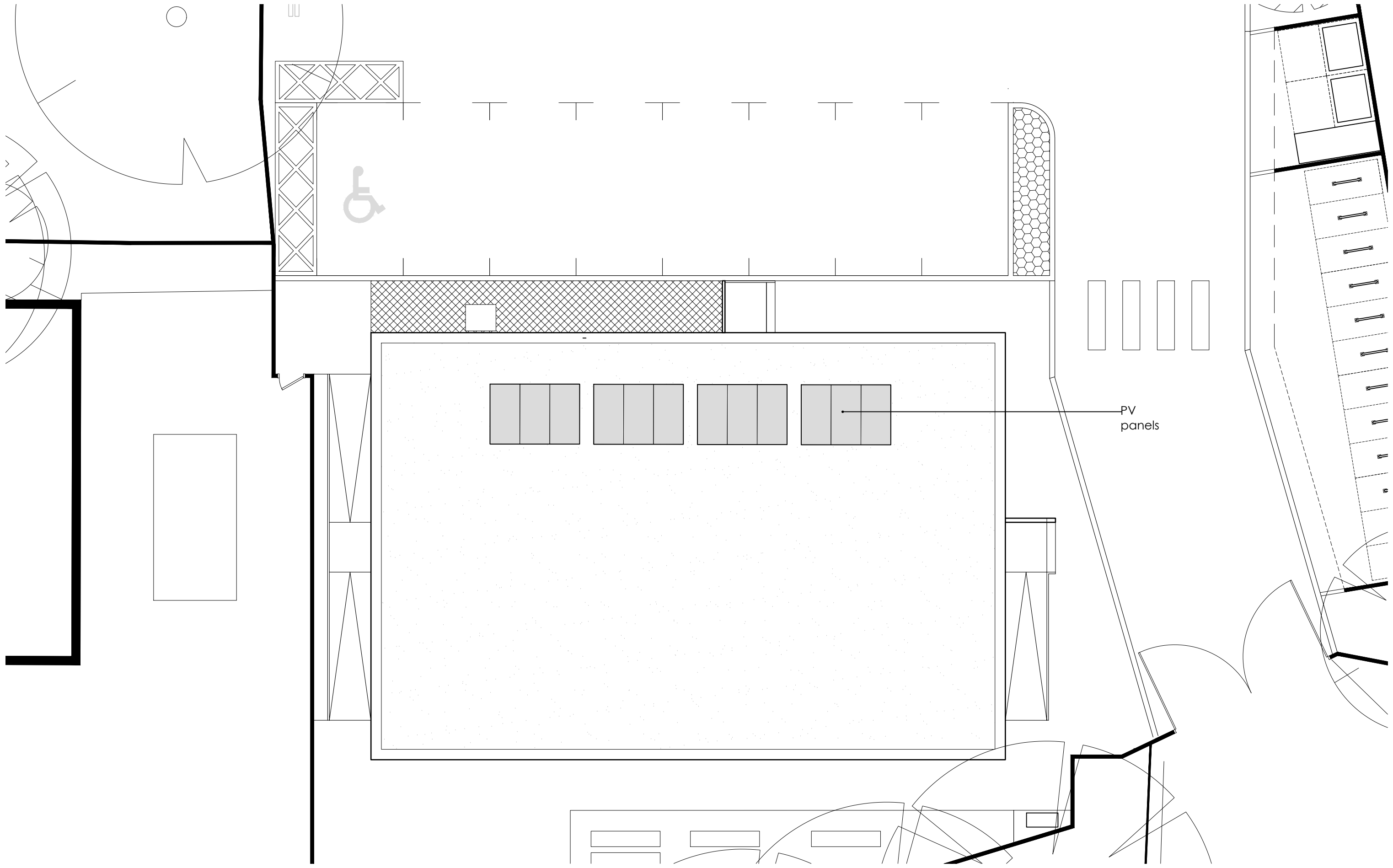

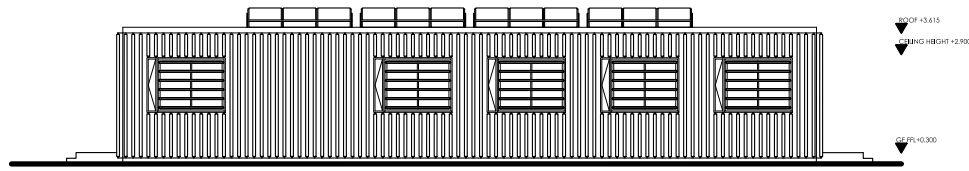

1 South elevation

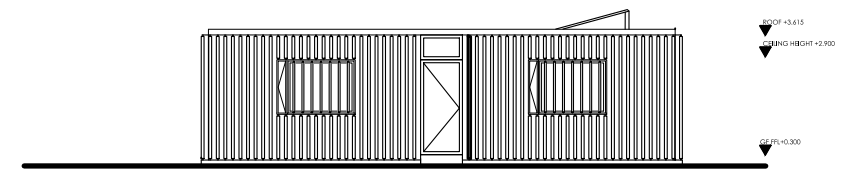

2 East elevation

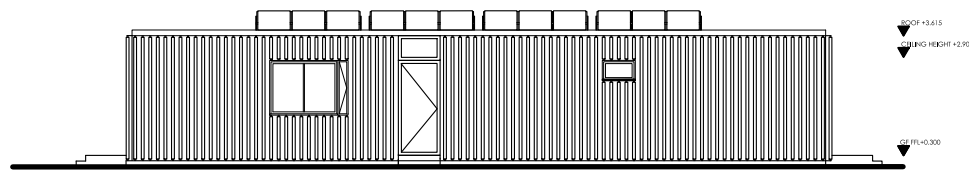

3 North elevation

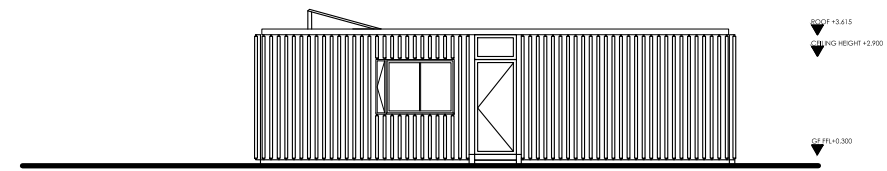

4 West elevation